

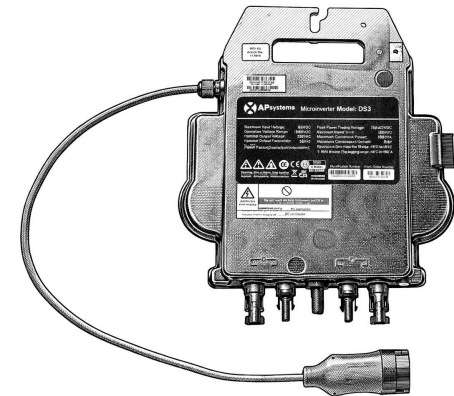

Drive a Zero-Carbon future
and make smart energy accessible for everyone

APsystems Microinverter Accessory & Connection Guide

- **APsystems DS3 Microinverter**
- **APsystems DS3D Microinverter**
- **APsystems QS2 Microinverter**
- **APsystems QT2 Microinverter**
- **APsystems QT2D Microinverter**



17th February 2026
EMEA

DS3 Microinverter



3-Wire Bus Cable End Cap
2060700017



Y3-DC Connector Unlock Tool
2061702007



Bus Cable Y-CONN Cap
2061702007



AC Connector CAP
2300931212 Male
2300932212 Female

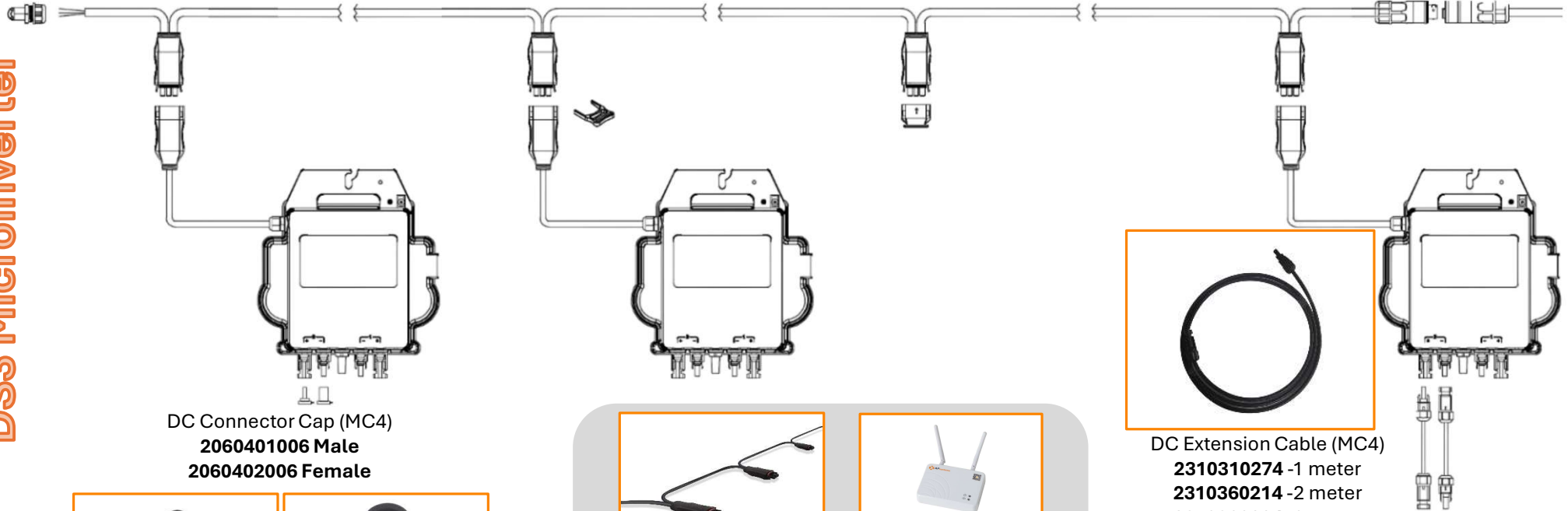

DC Connector Cap (MC4)
2060401006 Male
2060402006 Female



Single Phase Bus Cable
2322304903 (2.5mm², 2m)
2322601503 (4mm², 2.4m)
2334076132 (2.5mm², 1m)
3224049032 (2.5 mm², 4m)



ECU-R Gateway
209018



DC Extension Cable (MC4)
2310310274 -1 meter
2310360214 -2 meter
2310360224 -3 meter
2310370236 -4 meter

DS3D Microinverter



ACB3 Connector Female
2301432705



3-Wire Bus Cable End Cap
2060700017



Connector Unlock Tool
2301733005



Bus Cable Y-CONN Cap
2061702007



AC Connector CAP
2300931212 Male



2300932212 Female

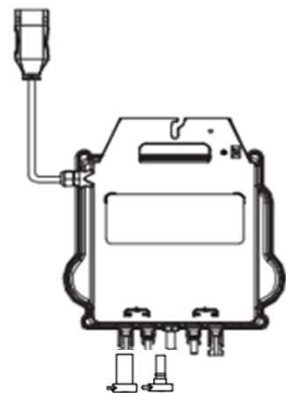

DC Connector Cap (MC4)
2060401006 Male
2060402006 Female

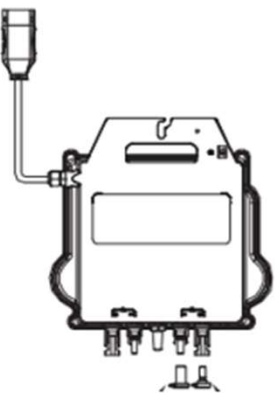

DC Extension Cable (MC4)
2310310274 -1 meter
2310360214 -2 meter
2310360224 -3 meter
2310370236 -4 meter

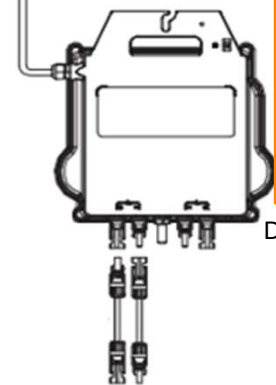

AC Branch Ext.cable
2334076132 2.5mm², 1m



Single Phase Bus Cable
2322304903 (2.5mm², 2m)
2322601503 (4mm², 2.4m)



ECU-R Gateway
209018

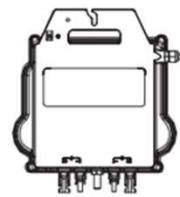

ACB3 Connector Female
2301432705



QS2 Microinverter



Bus Cable End Cap
2060700017



ACB3 Connector Female
2301432705



Connector Unlock Tool
2301733005



Bus Cable Y-CONN Cap
2061702007



ACT3 Connector Male
2301631505



ACT3 Connector Female
2301632505

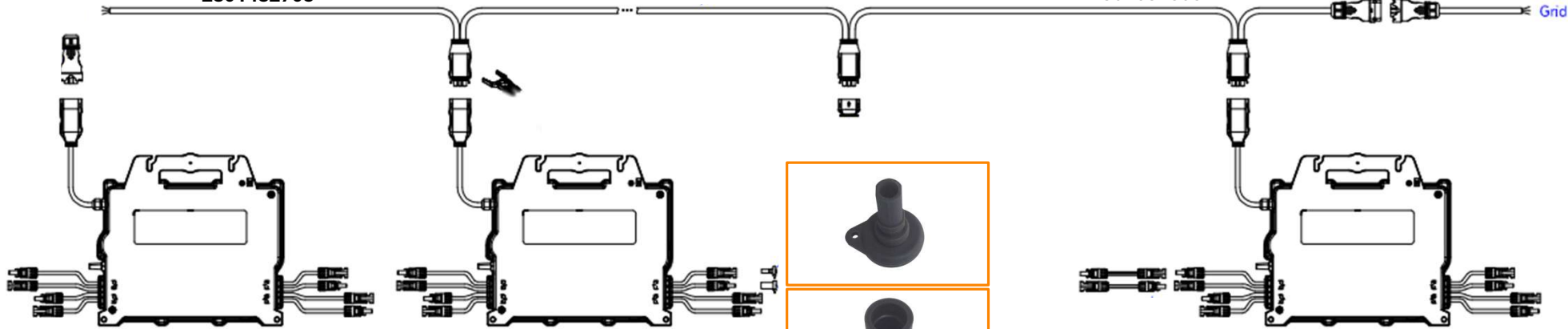

DC Connector Cap (MC4)
2060401006 Male
2060402006 Female



Single phase Bus Cable
2322304903 (2.5mm², 2m)
2322601503 (4mm², 2,4m)



ECU-R Gateway
209018

ACB3 Connector Female
2301432705
AC Branch Ext.cable
2334076132

Grid

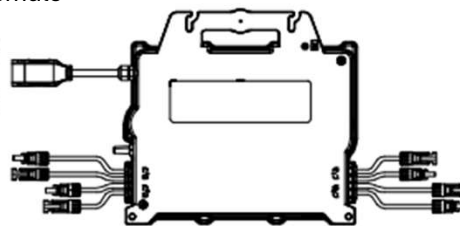

DC Extension Cable (MC4)
2310310274 - 1 meter
2310360214 - 2 meter
2310360224 - 3 meter
2310370236 - 4 meter



AC Branch Ext.cable
2334076132 2.5mm², 1m

QT2 Microinverter



5C Bus Cable End Cap
2062050012

3-phase 5C Bus Cable

5C Connector Unlock Tool
2353000002

5 Wire Cable T-CONN Cap
2061252032

AC Connector Male
2301511002

AC Connector Female
2301512002

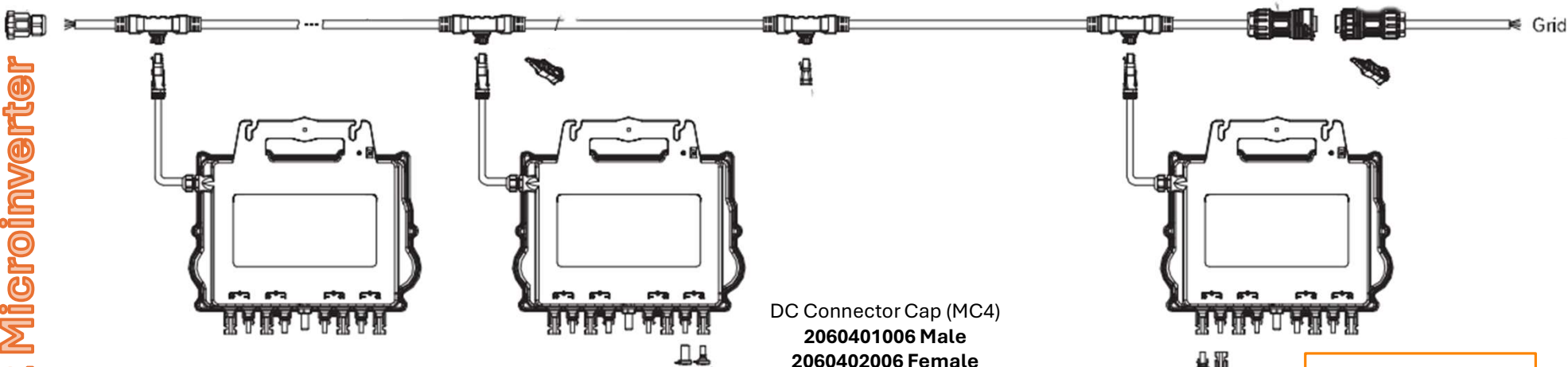

DC Connector Cap (MC4)
2060401006 Male
2060402006 Female



DC Extension Cable (MC4)
2310310274 - 1 meter
2310360214 - 2 meter
2310360224 - 3 meter
2310370236 - 4 meter



3-phase 5C Bus Cable
2322604802 (2.5mm², 2,4m)
2322900902 (2.5mm², 4,6m)
2322609122 (4mm², 2,4m)
2322909102 (4mm², 4,6m)

ECU-R Gateway
209018



QT2D Microinverter



5C Bus Cable End Cap
2062050012



3-phase 5C Bus Cable



5C Connector Unlock Tool
2353000002



5 Wire Cable T-CONN Cap
2061252032



AC Connector Male
2301511002



AC Connector Female
2301512002

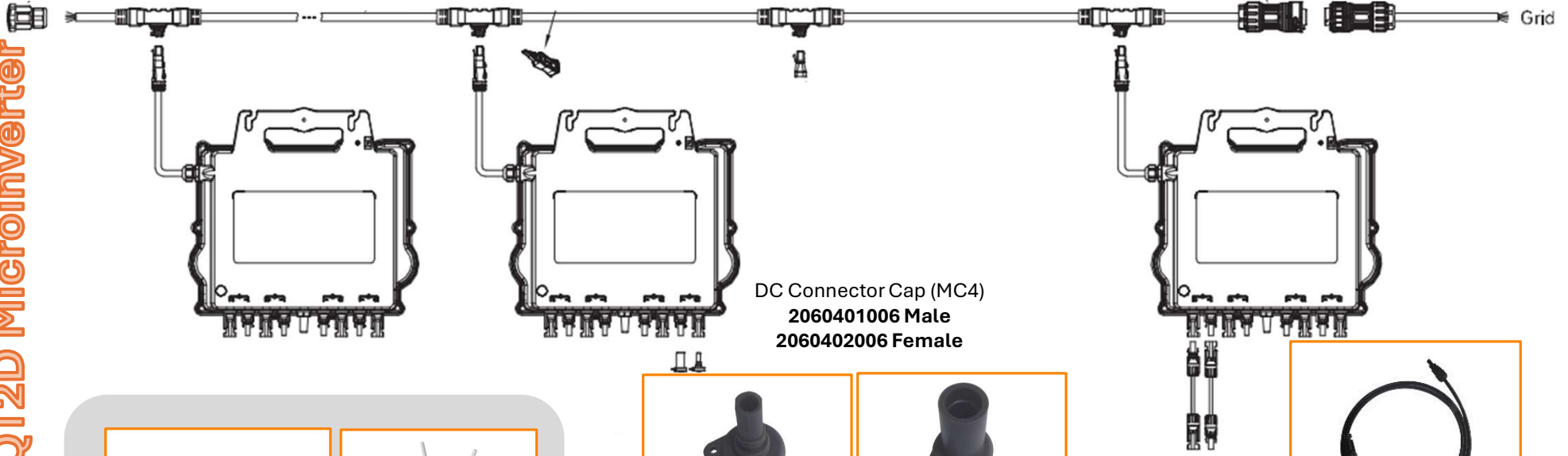

DC Connector Cap (MC4)
2060401006 Male
2060402006 Female



DC Extension Cable (MC4)
2310310274 - 1 meter
2310360214 - 2 meter
2310360224 - 3 meter
2310370236 - 4 meter
2310370246 - 6 meter



3-phase 5C Bus Cable
2322900902 (2.5mm², 4,6m)
2322909102 (4mm², 4,6m)



ECU-R Gateway
209018



APsystems
ALTENERGY POWER